

Schneeflocke 11



Blockgröße: 6 x 6 inch



© Claudia Hasenbach 2018
Nußbaumerstraße 292
D - 50825 Köln

www.claudias-quilts.de
email: pattern@claudias-quilts.de

Artwork by www.graphicgarden.de

Stoffbedarf:

- hellblau oder -grau für den Hintergrund
- weiß für die Schneeflocke

A Schneeflocke = Blockgröße 6 x 6 inch

A Schneeflocke = Blockgröße 10 x 10 inch

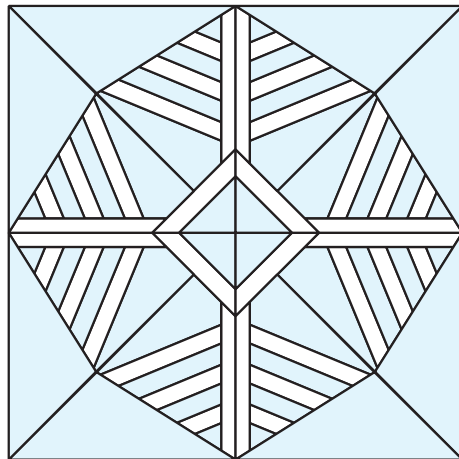

Hintergrund



Schneeflocke

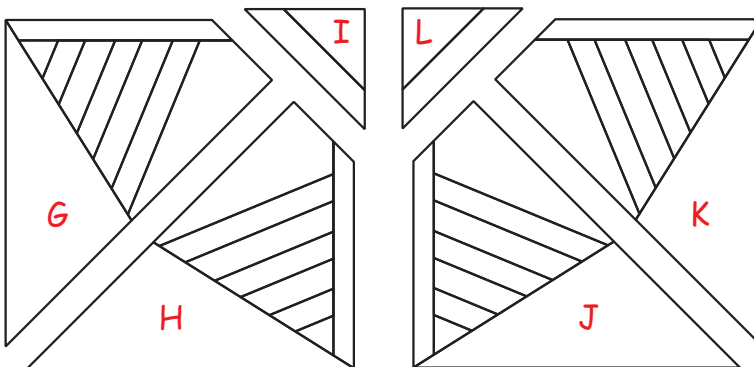
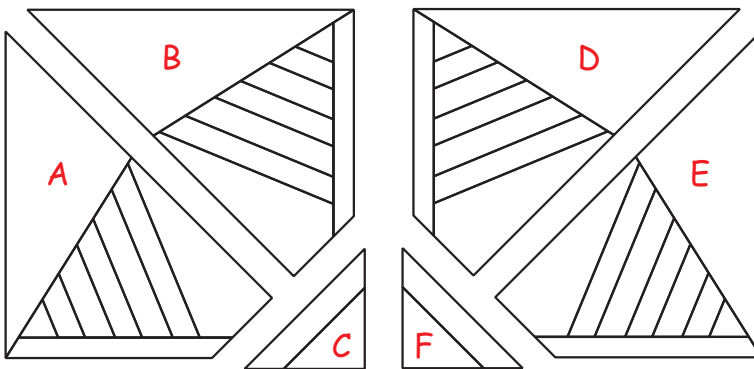

Nähreihenfolge:

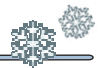

1. A + B
2. AB + C
3. D + E
4. DE + F
5. G + H
6. GH + I
7. J + K
8. JK + L
9. ABC + DEF
10. GHI + JKL
11. ABCDEF + GHIJKL

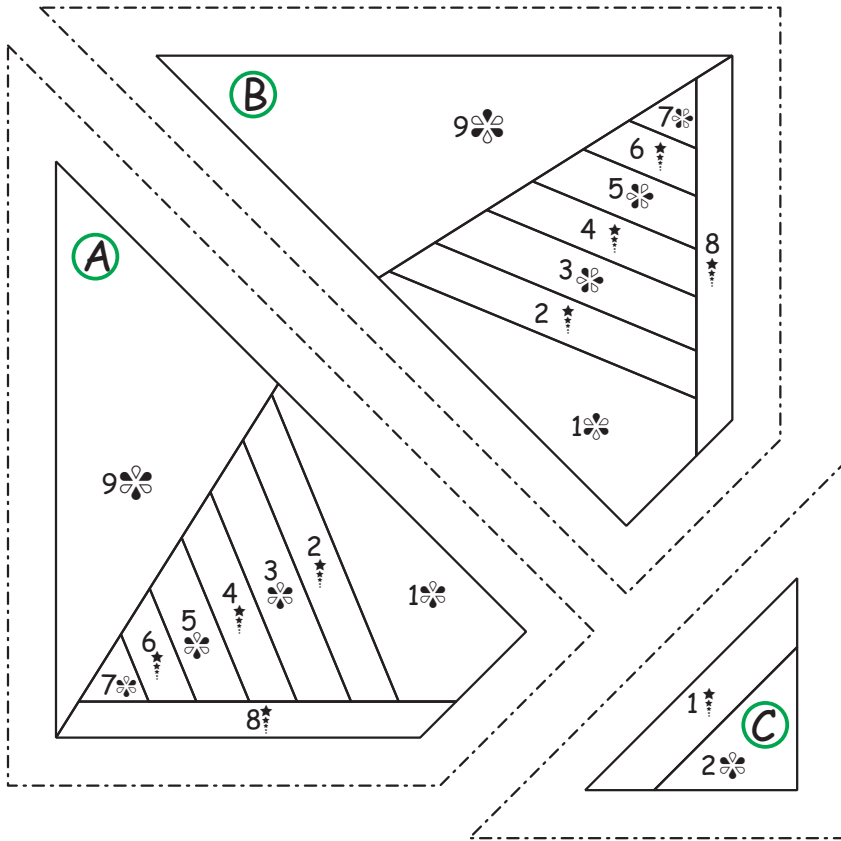

Schneeflocke 11
pp-pattern 1/2

1 inch
nach dem
Drucken
bitte messen!

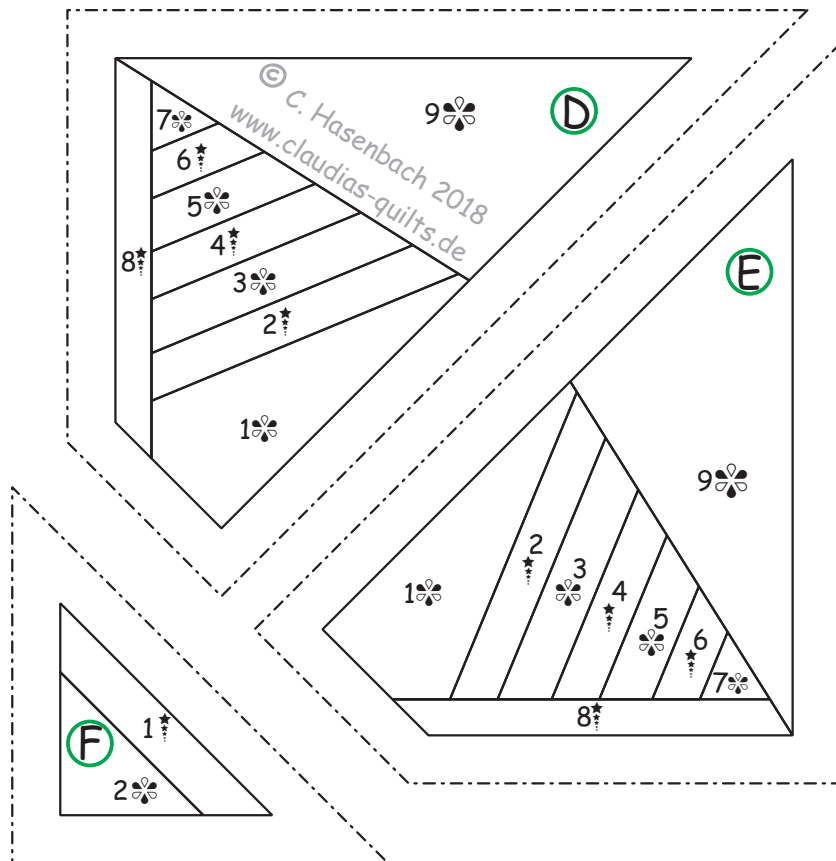

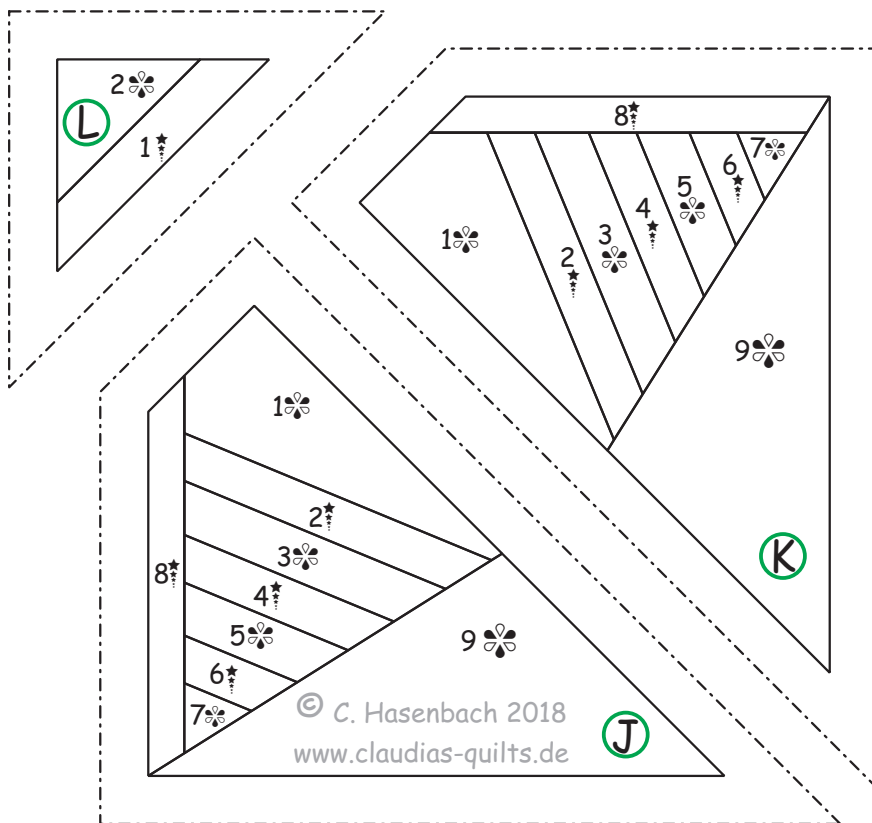
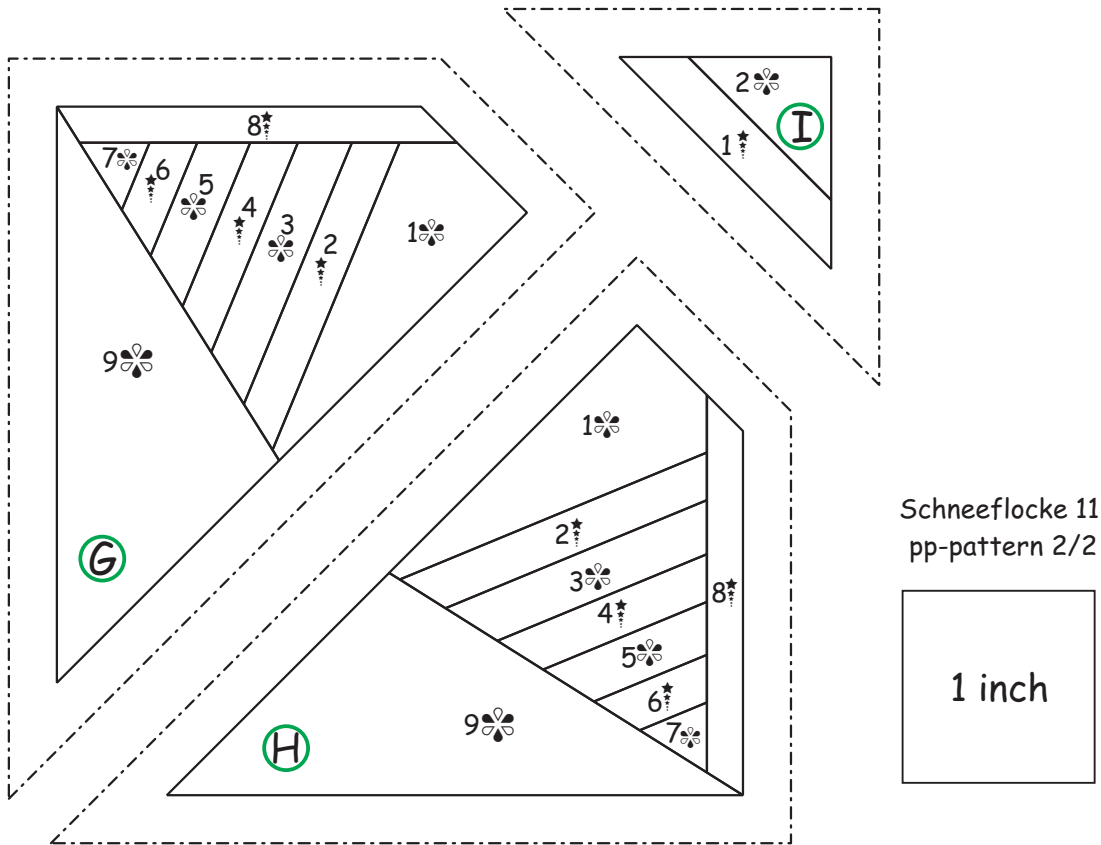

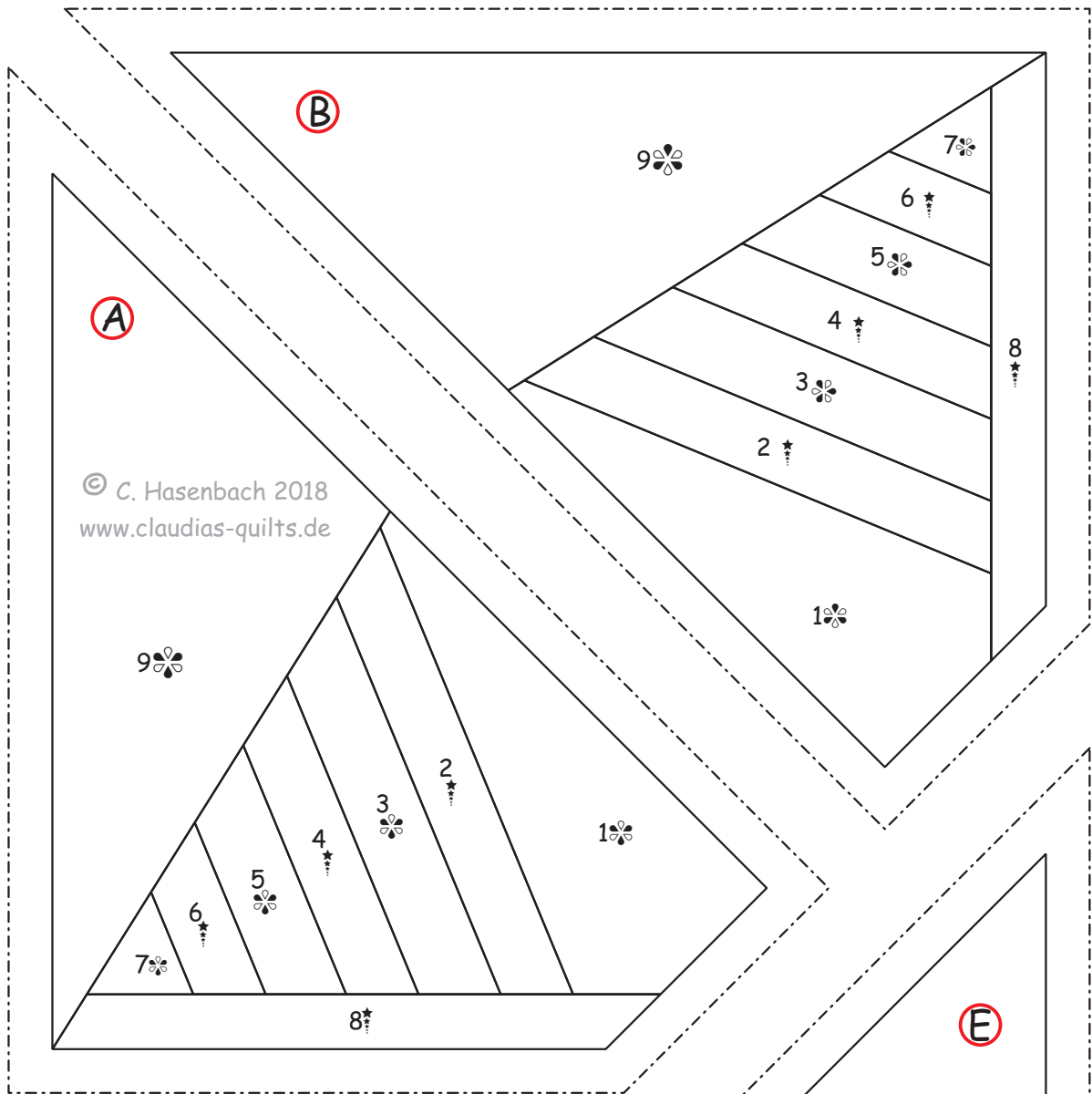

1 inch
nach dem
Drucken
bitte messen!

Schneeflocke 11
pp-pattern 1/3

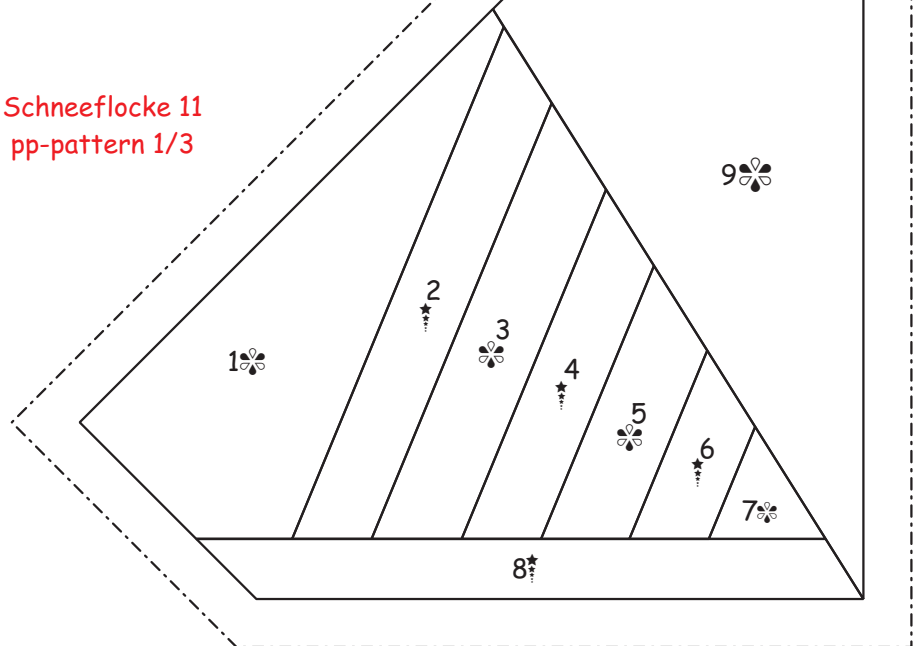

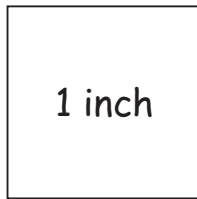
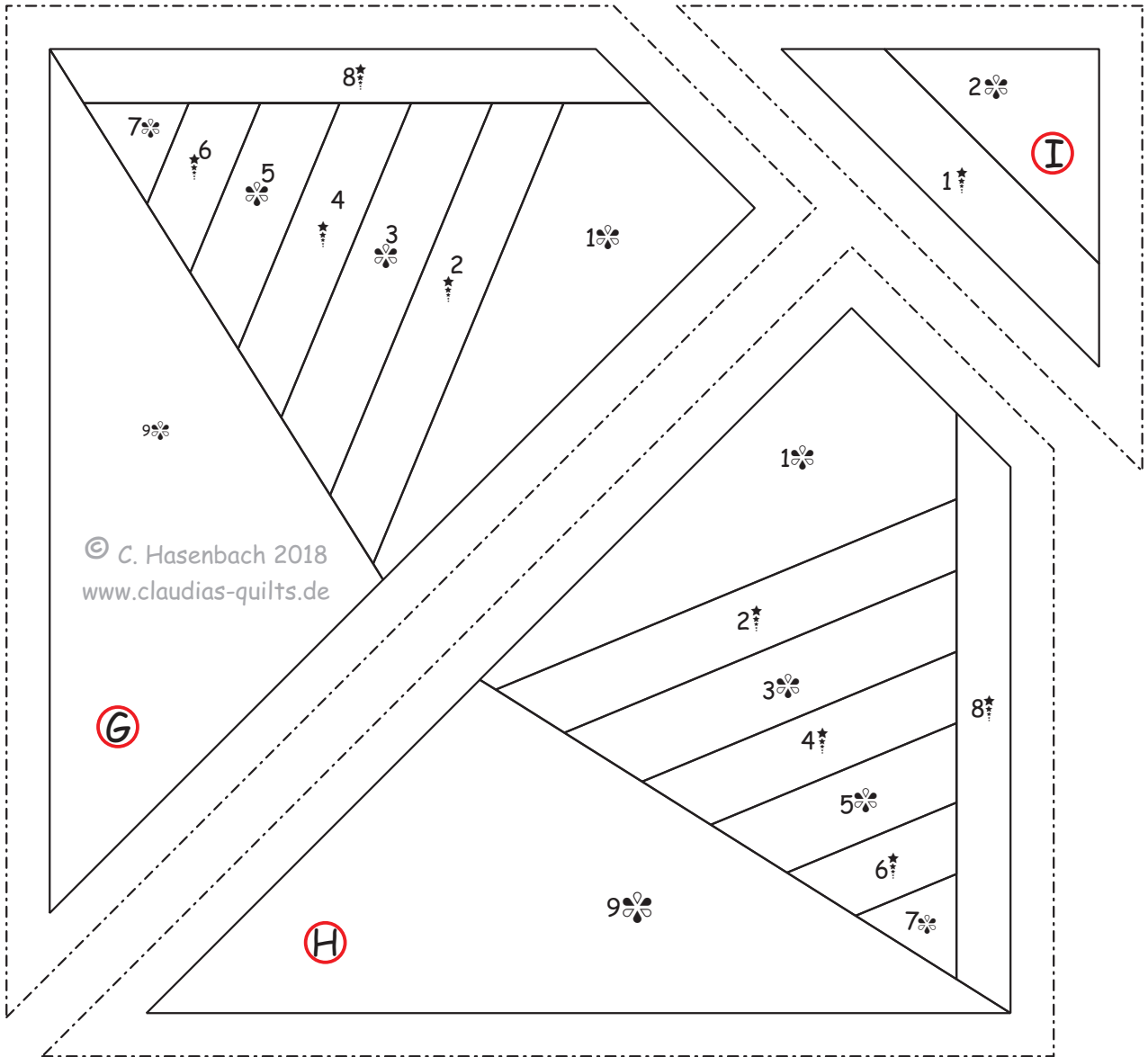

Schneeflocke 11
pp-pattern 2/3

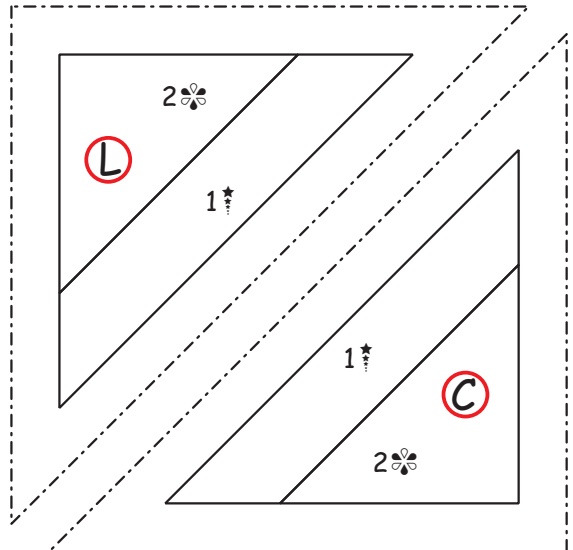
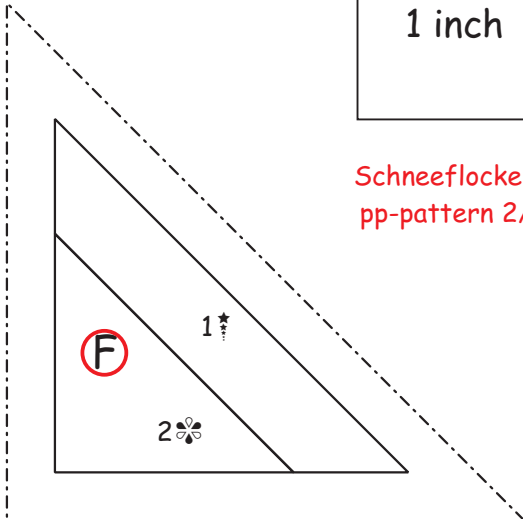

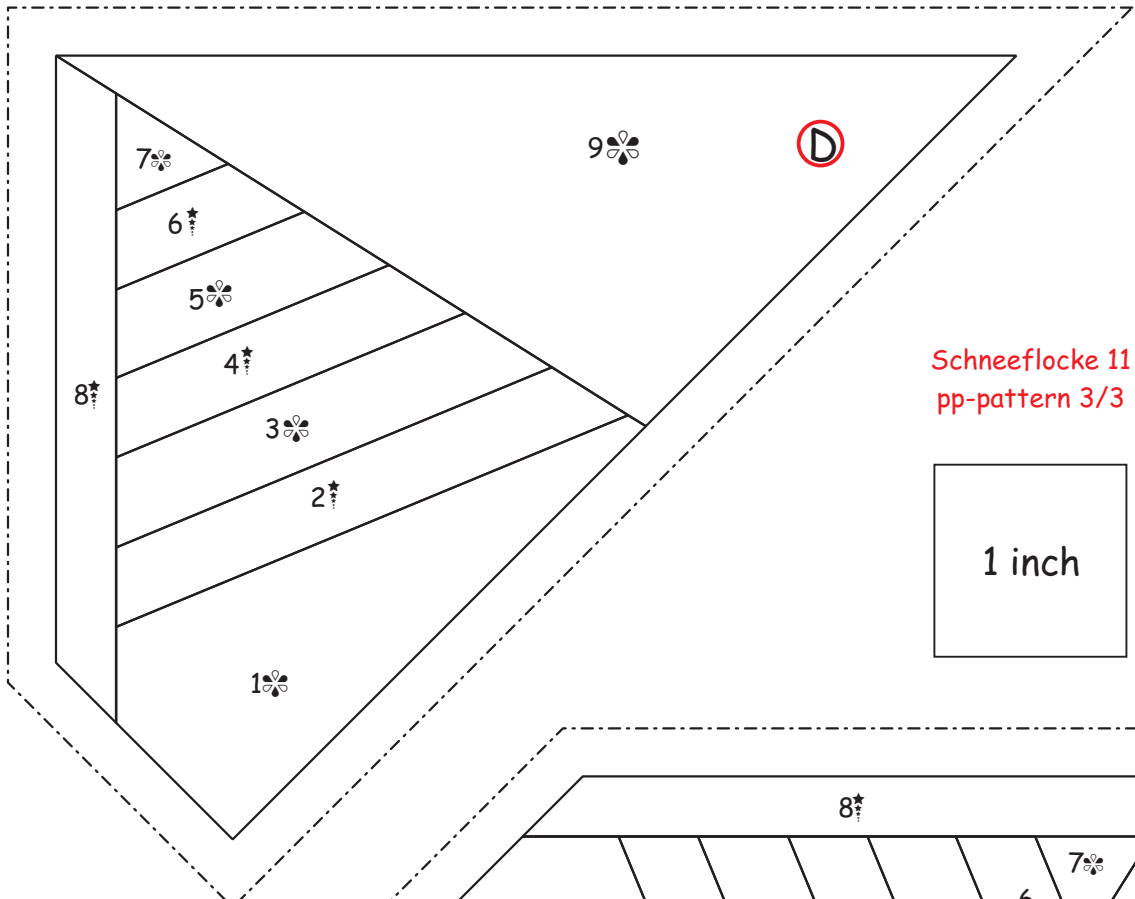

Schneeflocke 11
pp-pattern 3/3

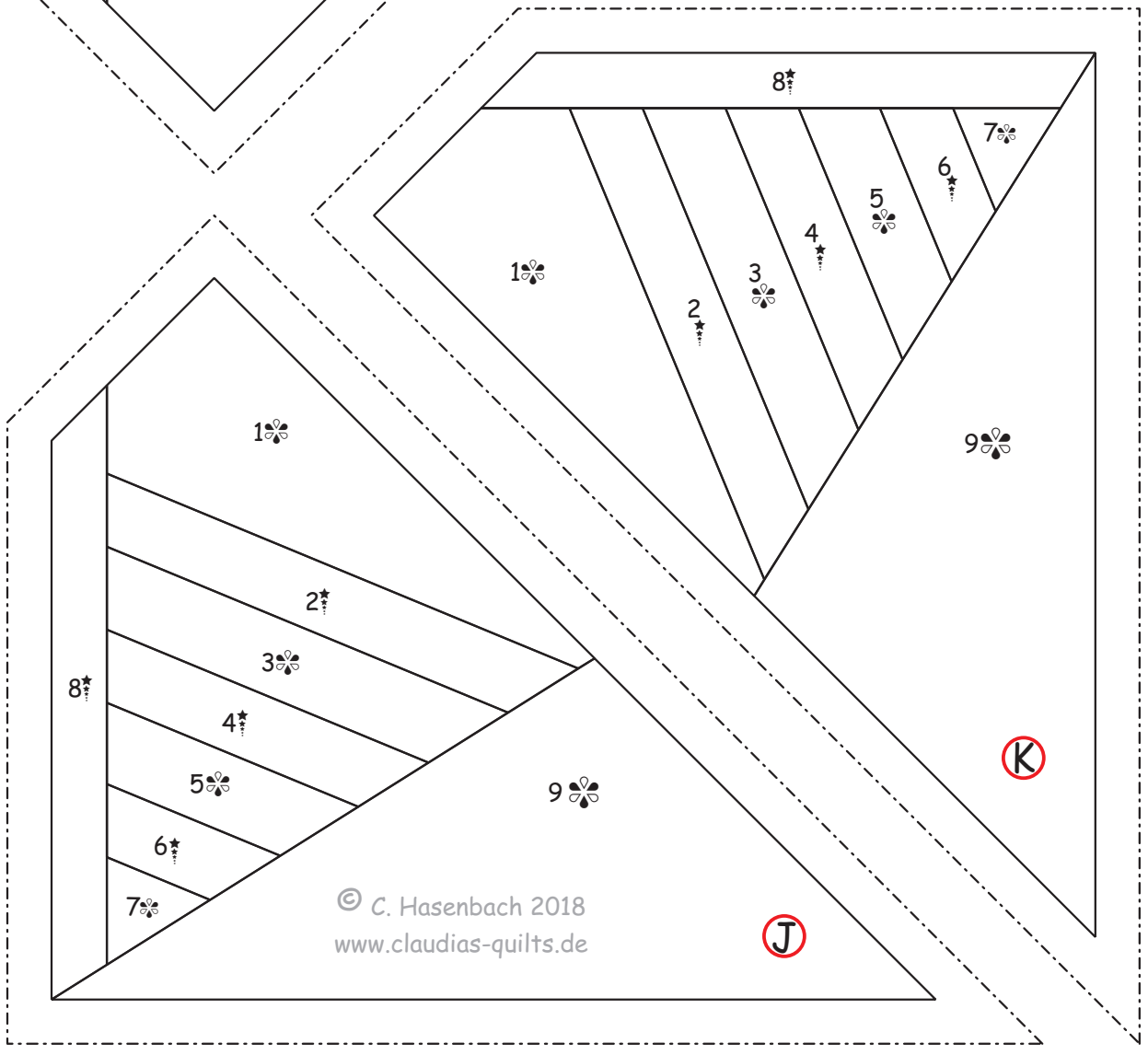
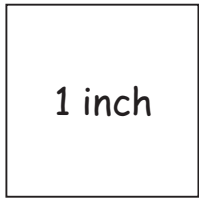

© C. Hasenbach 2018
www.claudias-quilts.de