

# Schwefelgelber Schmetterling

*Anteos maerula*

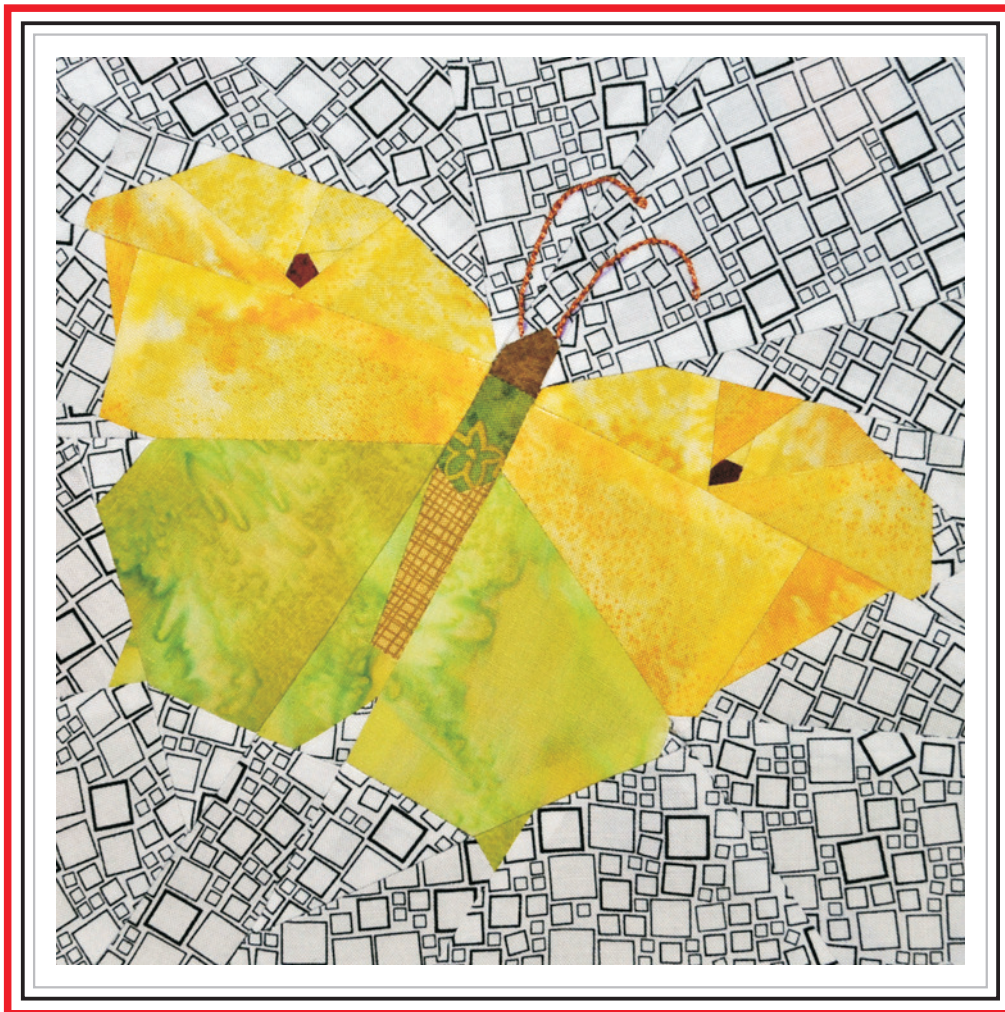

Blockgröße: 8 x 8 inch



© Claudia Hasenbach 2016  
Nußbaumerstraße 292  
D - 50825 Köln

[www.claudias-quilts.de](http://www.claudias-quilts.de)  
email: [pattern@claudias-quilts.de](mailto:pattern@claudias-quilts.de)

Artwork by [www.graphicgarden.de](http://www.graphicgarden.de)

Stoffbedarf:

- ca. 20 cm Stoff für den Hintergrund
- gelb, grünlichgelb und braun für die Flügel
- hellbraun, grün und gelb für den Körper

Außerdem:

- Stickgarn für die Fühler

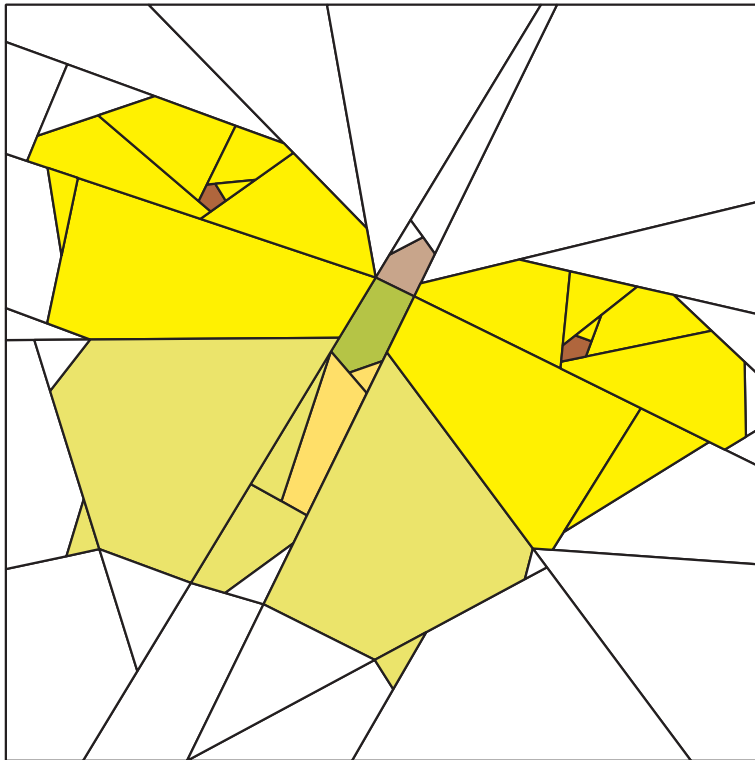

Hintergrund



Schmetterling

Stickstiche:

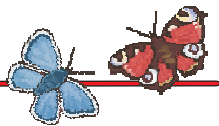

Die Fühler des Schmetterlings im Stielstich arbeiten. An die Enden einen kleinen Margeritenstich sticken oder eventuell kleine Perlen aufnähen.

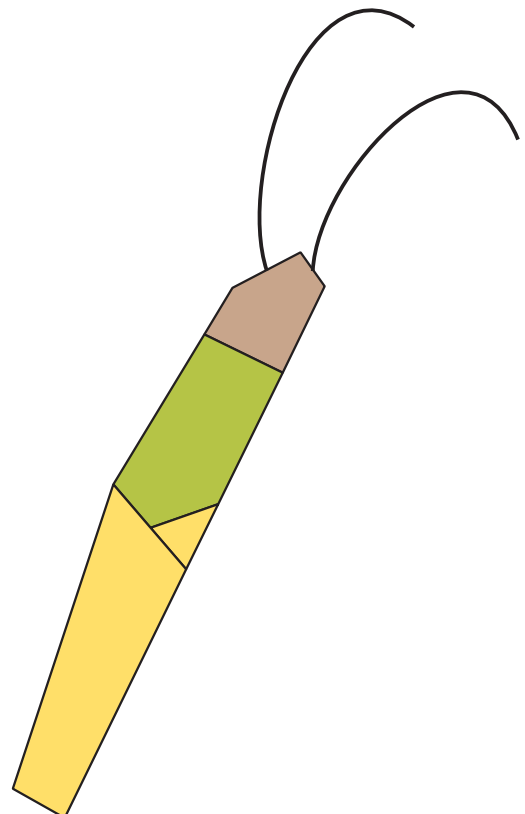

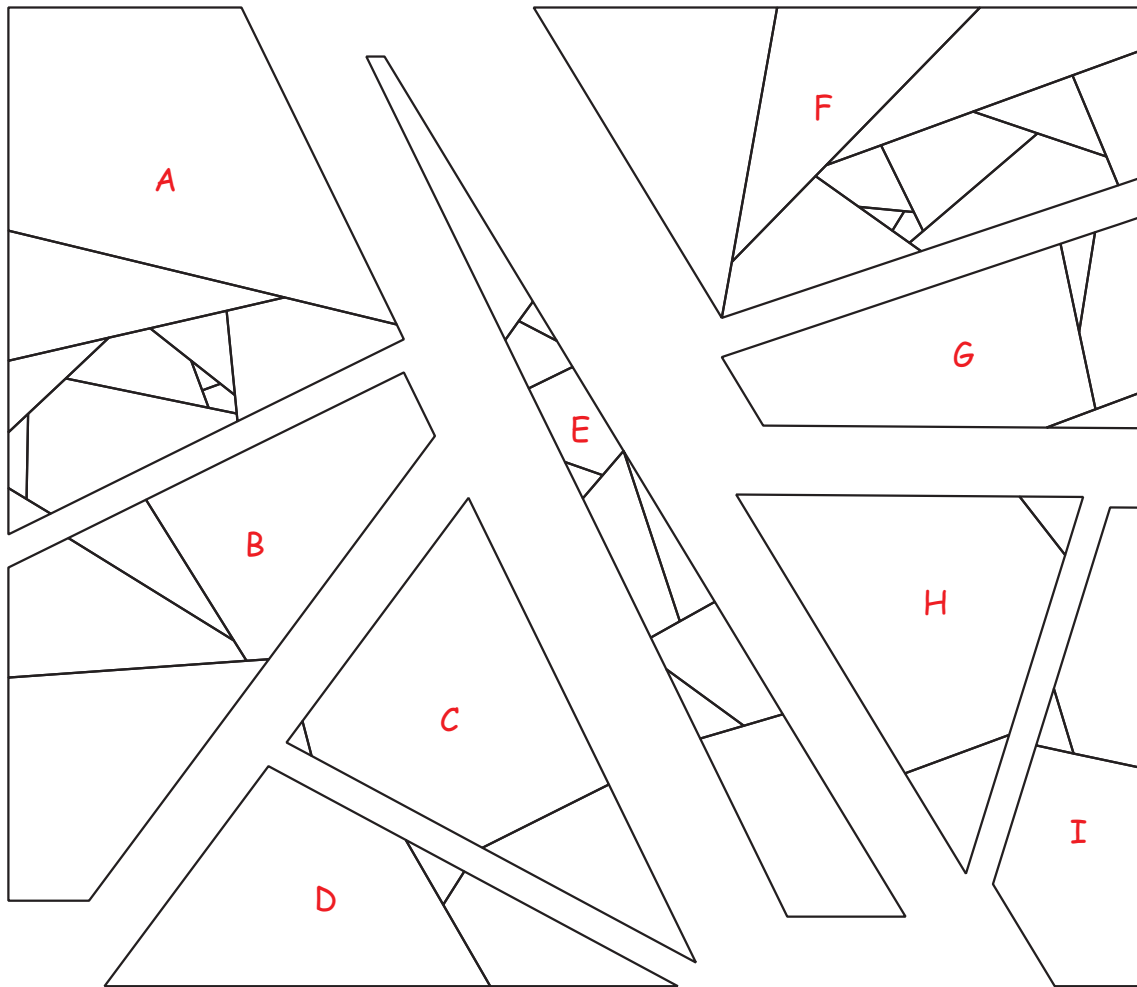

Nähreihenfolge:

1.  $A + B$
2.  $C + D$
3.  $AB + CD$

4.  $F + G$
5.  $H + I$
6.  $FG + HI$

7.  $ABCD + E$
8.  $ABCDE + FGHI$

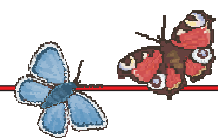

Schwefelgelber Schmetterling  
pp-pattern 1/3

1 inch  
nach dem  
Drucken  
bitte messen!

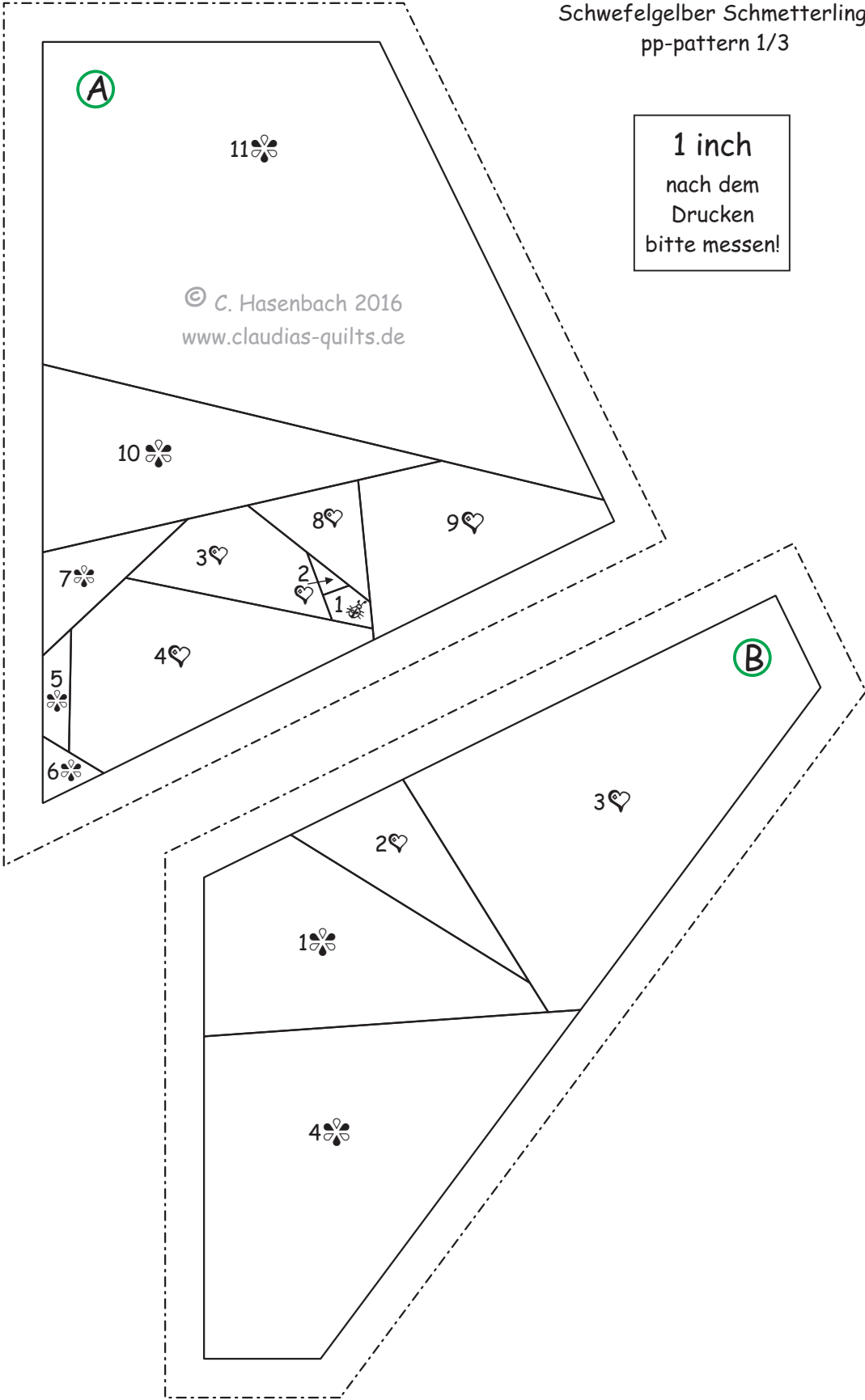

A

11

© C. Hasenbach 2016  
www.claudias-quilts.de

10

8

9

3

7

2

1

4

5

6

B

3

2

1

4

Schwefelgelber Schmetterling  
pp-pattern 2/3

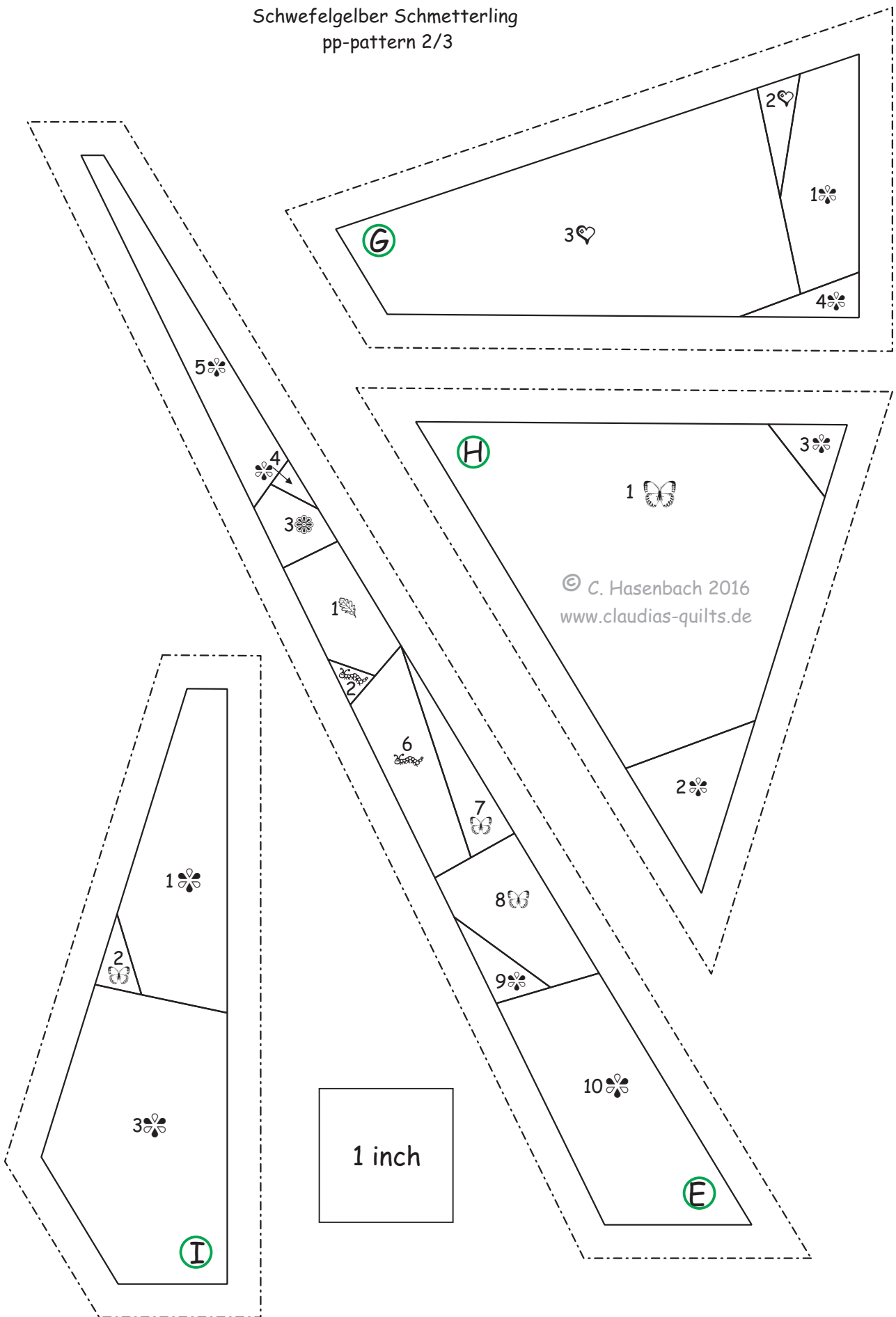

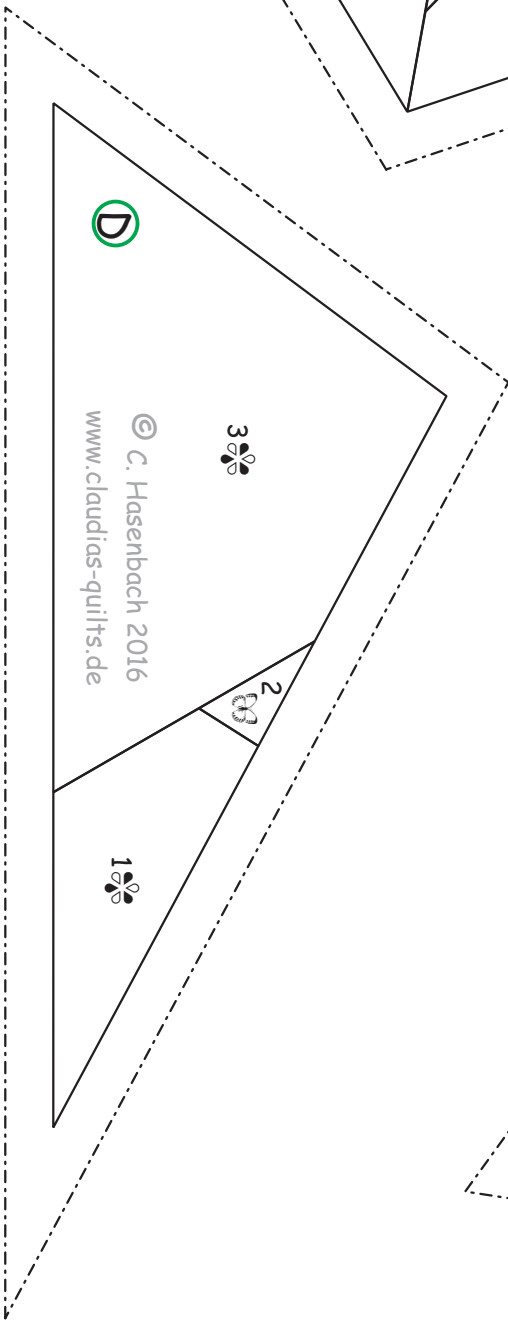
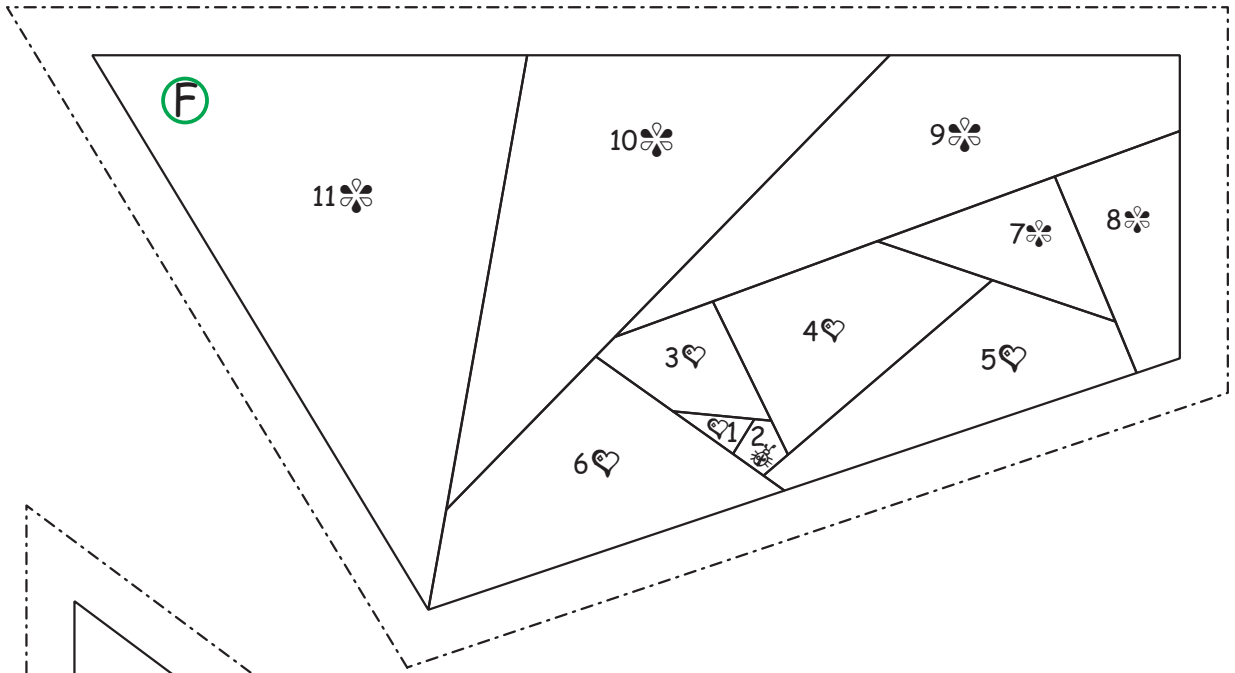

Schwefelgelber Schmetterling  
 pp-pattern 3/3

